

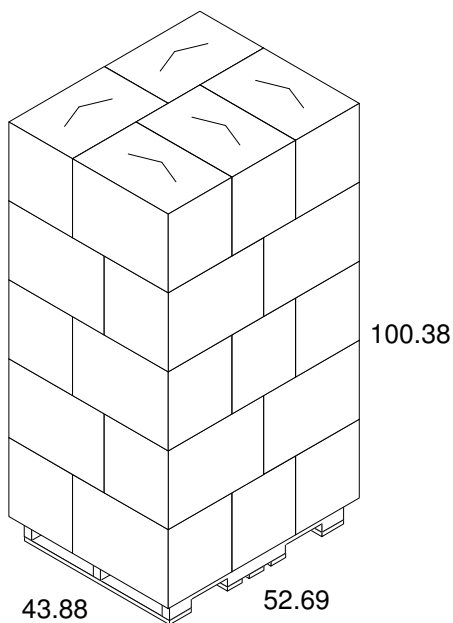

SBT503

Date Printed : 2/7/2018
Last Saved : 2/7/2018

Tops Engineering



53 FT. Dry Van 630.0x98.0x110.0				
	Shipper (ID)	Shipper (OD)	UnitLoad (Incl. Pal)	Vehicle Load
Ln:	26.000 in	26.313 in	52.69 in	623.44 in
Wd:	17.250 in	17.563 in	43.88 in	96.6 in
Ht:	18.250 in	18.875 in	100.38 in	100.4 in
Net:		0.00 lb	0.00 lb	0.00 lb
Grs:		0.00 lb	65.00 lb	1690.00 lb
Cube:	4.737 ft3	5.048 ft3	134.279 ft3	33496.903 ft3
		Height Vert		
Shipper:			25	650
UnitLoads:				26
Area Efficiency:		0.00 %	120.34 %	97.35 %
Cubic Efficiency:		0.00 %	113.57 %	88.83 %
Cases per layer:			5	650
UL per layer:				26
Layers/load:			5	1
Pattern:			Interlock	Pinwheel
RSC Area:		22.20 ft2	555 ft2	14433 ft2
Density (gr/cc):			0.0000	0.0000

GMA (Notched) 48.00x40.00x6.00				
	Shipper (ID)	Shipper (OD)	UnitLoad (Incl. Pal)	Vehicle Load
Ln:	26.000 in	26.313 in	52.69 in	623.44 in
Wd:	17.250 in	17.563 in	43.88 in	96.6 in
Ht:	18.250 in	18.875 in	100.38 in	100.4 in
Net:		0.00 lb	0.00 lb	0.00 lb
Grs:		0.00 lb	65.00 lb	1690.00 lb
Cube:	4.737 ft3	5.048 ft3	134.279 ft3	33496.903 ft3
		Height Vert		
Shipper:			25	650
UnitLoads:				26
Area Efficiency:		0.00 %	120.34 %	97.35 %
Cubic Efficiency:		0.00 %	113.57 %	88.83 %
Cases per layer:			5	650
UL per layer:				26
Layers/load:			5	1
Pattern:			Interlock	Pinwheel
RSC Area:		22.20 ft2	555 ft2	14433 ft2
Density (gr/cc):			0.0000	0.0000

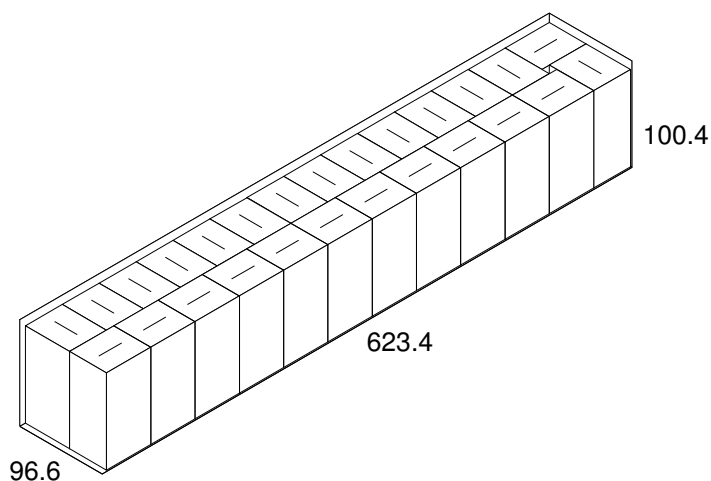

Notes: